

Start-up instructions

Thyristor controller Type: TS2 3Ph, TS2 SP 3Ph Three phase controller W3C

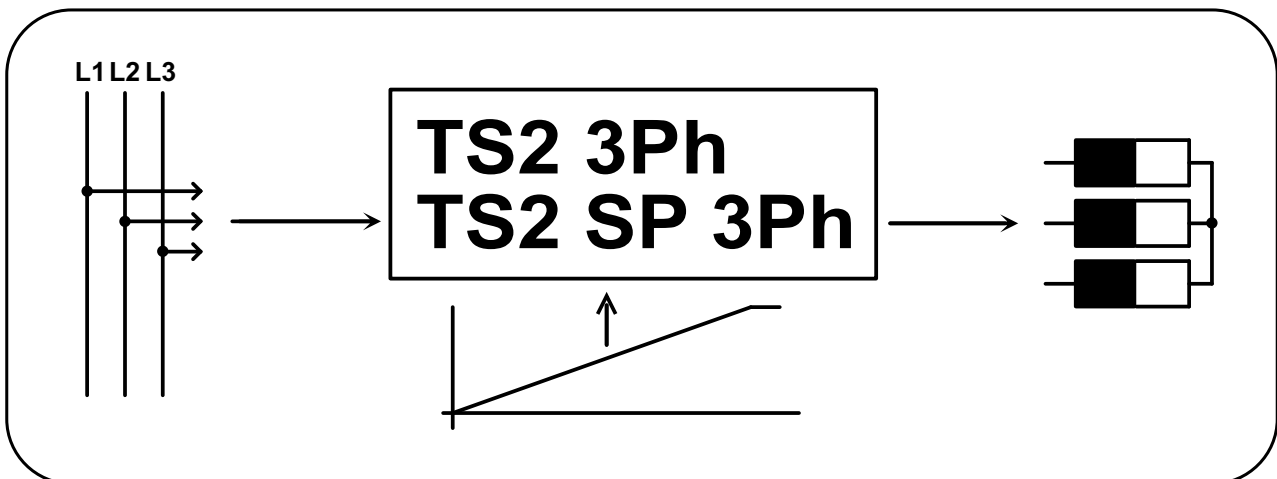

Content

	Page
1. Important safety instructions.....	2
2. General instructions.....	2
3. Technical explanations on thyristor controllers.....	3
3.1 Explanation phase angle control Ph.....	4
3.2 Explanation multicycle control SP (burst-firing control).....	5
4. Installation of the thyristor controller TS2 3Ph, TS2 SP 3Ph.....	6
5. EMC-equitable assembly.....	6
6. Operation.....	8
7. Technical features of the control and monitoring panel.....	9
7.1 Meaning of the LEDs.....	9
7.2 Meaning of the clamp connections.....	10
8. Control and monitoring print.....	11
9. Control unit.....	12
9.1 Function board.....	12
9.2 Settings for the various controls.....	13
10. Basic circuit.....	14
11. Survey of the individual types.....	15
12. Technical data.....	16
13. Optionen and equipment.....	16
14. Frame sizes.....	17

1. Important safety instructions

This manual contains instructions, which have to be observed for your personal safety and for the prevention of material damage. The instructions about your personal safety are highlighted with a warning triangle labelled with three exclamation marks, hints about material damages are listed with a warning triangle and one exclamation mark.



Danger-symbol

Personal injury **may** occur, if appropriate safety precautions are not taken.



Caution-symbol

Material damages may occur, if appropriate safety precautions are not taken into account.



Disposal regulations

The devices contain electrical components and must not be disposed together with household garbage. The devices for disposal have to be recycled according to local and currently valid regulations for electronic waste.

Qualified personnel

The corresponding device/system may only be set up and operated in conjunction with this documentation. Commissioning and operation of the device/system may only be performed by **qualified personnel**. Qualified personnel within the meaning of the safety instructions in this documentation are persons with the authority to put electric circuits into operation, provide ground connections and label them according to current safety regulations.

The device should only be used in applications described in this document. The reliable and proper use of the product depends on appropriate transport, storage, installation and careful commissioning.

2. General instructions

Use of the document

This instruction should demonstrate the technical application possibilities of the thyristor controller to the engineer in charge.

Target group

The document should assist the user during commissioning. It also helps in case of service and maintenance work. It supports the planner and project engineer with the conception of new plants.

Necessary competence

Generic skills in the field of electrical engineering are necessary.

Validity

The present document is valid for the thyristor controller of the type ESGT-3Ph... . It contains the currently valid description of the unit. We reserve the right to attach new descriptions of the devices. This involves types and options with modified version status of the technical documents.

Standards and approvals

The thyristor controller of the type TS2 3Ph... are based on the IEC/EN 60947-4-3 standard.

Disclaimer

It lies within the responsibility of the plant manufacturer of the technical equipment or machine to ensure the proper overall function. The producer can not guarantee all properties of the overall system or the machine.

3. Technical explanations on thyristor controllers

The thyristor controller is more and more used in sectors, in which bigger loads of ohm and inductive loads have to be regulated (i.e.: building of industrial furnaces, plastics processing, etc.).

Due to its modular, compact construction and its controlling by a continual control signal, these wattage regulators become a perfect device for industrial control of wattage input. The power element of the thyristor controller consists at the TS2 1Ph... of two, at the TS2 3Ph of six antiparallel connected thyristors, the isolated cooling system and the electronic regulation and watching.

Type description:

TS2 3Ph...	three phase controller, phase angle control
TS2 1Ph...	single phase controller, phase angle control
TS2 SP 3Ph...	three phase controller (multicycle control)
TS2 SP 1Ph...	single phase controller (multicycle control)

Thyristor controllers for phase angle control (TS2 3Ph... and TS2 1Ph...) serve to control ohmic and inductive loads. The activation is standardly made via proportional signals (0...10V, 0...20mA or 4...20mA). The phase angle or the on and off clock ratio with multicycle control is constantly adjusted by the control electronics, to achieve a sufficient proportionality between the activation and the output (T1, T2, T3) of the thyristor controller. Aside from the device series already mentioned, we have single and three phase versions, which cover the lower current range up to 12A. These devices are also available in snap-on design.

Current limiting:

At firing mode the current load can be regulated by a potentiometer between 1 and 100%. As a matter of fact the actual value of the current load is limited.

Auxiliary Voltage:

The devices are powered internal by the mains voltage. Optional can devices with different mains voltage be supplied with an external auxiliary voltage.

Construction:

The thyristor controller agrees with VDE 0558 part 1 and VDE 0160 table 4.

The thyristor controller TS2 3Ph... is assembled modularly. It consists of three basic elements:

- power unit with heat sink and thyristor wiring
- control and monitoring unit with ignition electronics (diagnostic display, control output, etc.)
- function board
- optional can devices with different mains voltage be supplied by an external auxiliary voltage

3.1 Explanation phase angle control Ph

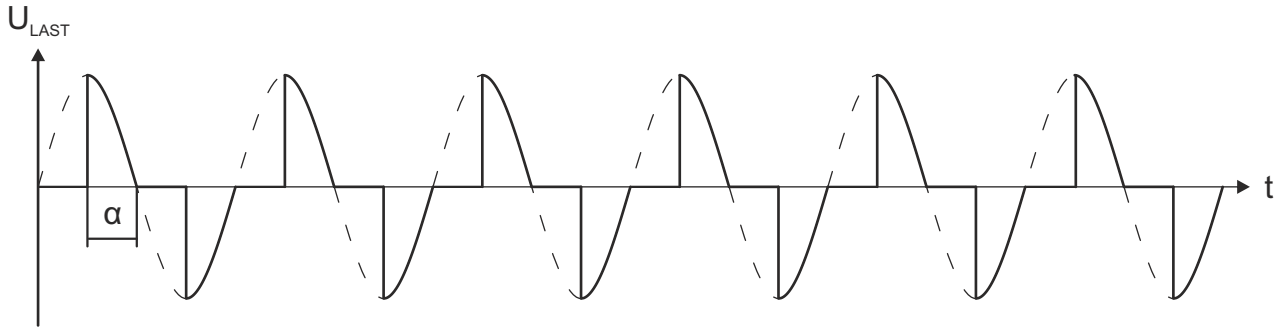

The phase angle control is an electrotechnical method to regulate the electrical power of loads with single phase current or three phase current. A typical use of this technology is dimming of light bulbs and various inductive and ohmic components. The effective value of the voltage as well as the electrical power consumption of the load can be changed by altering the switch-on moment. For many electrical engines with suitable construction (for example universal motors, asynchronous motors, fan motors or pump motors) a phase angle control can be used to control speed and torque. Due to the controllability of the positive and negative half-wave it is possible to adjust exactly the load voltage and to implement precise control applications. The variation of the phase angle α also allows the control of transformers for softstart- and control applications.

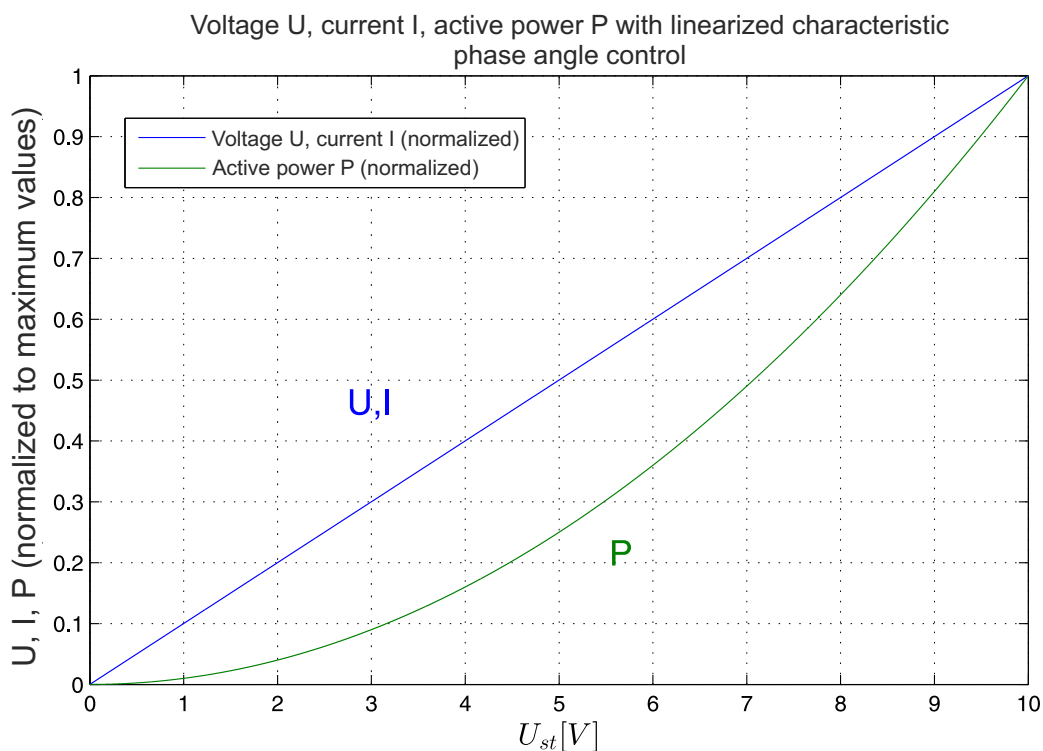

U_{\max}
 I_{\max}
 P_{\max}

$$P = U_{\max} \cdot I_{\max} \cdot \left(\frac{U_{st} [V]}{10V} \right)^2$$

$$U = U_{\max} \cdot \frac{U_{st} [V]}{10V}$$

$$I = I_{\max} \cdot \frac{U_{st} [V]}{10V}$$

3.2 Explanation multicycle control (burst-firing control)

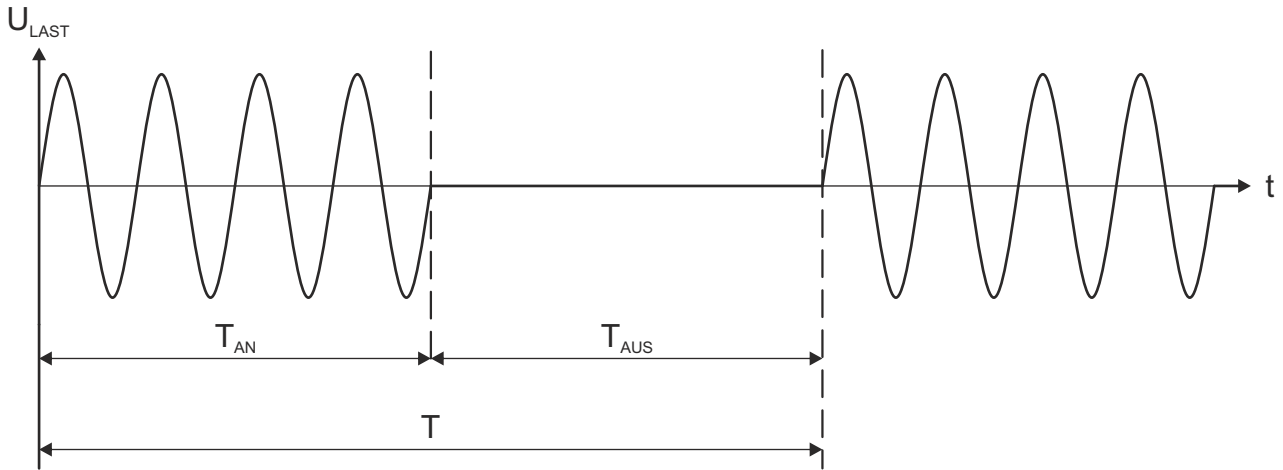

In this operating mode the thyristor controller ensures the targeted switching of individual full waves of the power supply. Depending on the control signal individual halfwaves (positive half-waves, negative half-waves) and wave packets can be switched, in which the switching point is always at the sinus zero crossing. The impulse(T_{AN})-pause(T_{AUS})-ratio controls the electrical power. This kind of operation mode reduces system perturbation. As basis for the switching intervals (impulse-pause-ratio) the devices normally operate with a time base T of one second (1s corresponds to 50 full-waves). Possible application areas are electric heatings, heat technology, and drying technology. Newer models offer combinations of phase angle control and multicycle control SP as well as different adjustment options in relating to the impulse (T_{AN})-pause(T_{AUS})-ratio.

For example:

A control signal of $U_{st} = 5V$ with a control range of 0 to 10V creates a impulse duration T_{AN} of 25 full-waves (500 ms) and a pause duration T_{AUS} of 25 full-waves (500ms).

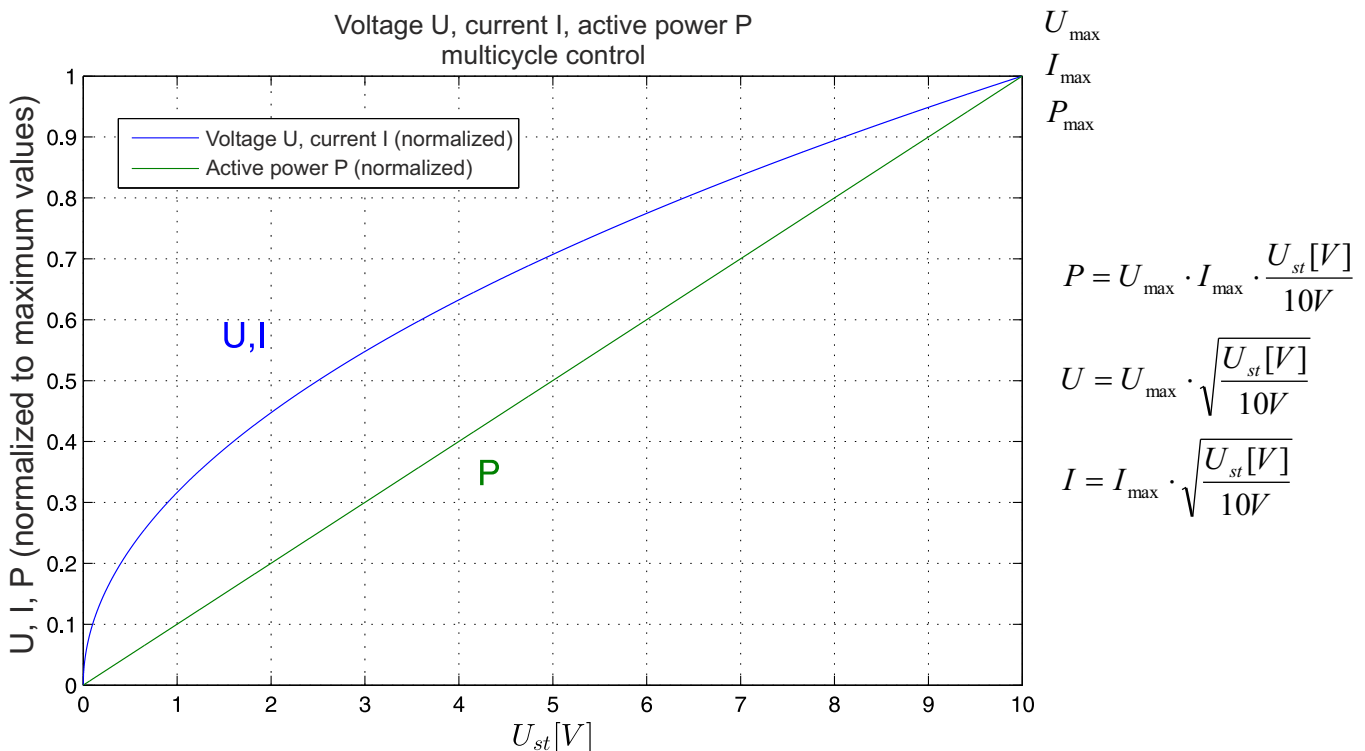

4. Installation of the thyristor controller TS2 3Ph, TS2 SP 3Ph

The built-in device, according to IP 23 has to be mounted in a housing or a switchboard panel. Take care of adequate cooling (separate ventilation, for instance). The environment temperature must not exceed the value of 55°C. The device is to be mounted on a vertical plane, avoiding that the ventilating pipes of the cooling element are not placed vertical. The device has to be mounted in a dry room.

Further conditions to the operating area:



- protection from dust and moisture
- protection from aggressive atmosphere
- free from vibrations

No other devices should be placed closer than 50 to 100mm to the device, in order to provide adequate cooling.

The housing equipment according to IP 54 can be placed in locations which are not protected from dust and moisture.

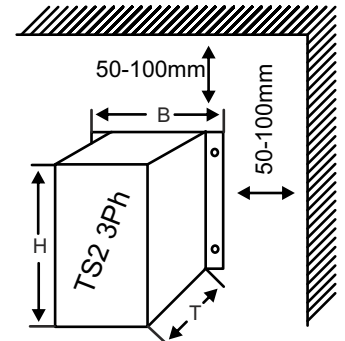

Wiring the device:



Build mains connection (L1, L2, L3) via fused circuit breakers with usual fuses.

The wiring for power supply and the wiring for control have to be laid in separate conduits or shield ducts.

It is essential to the electric installation to comply to the stipulations of the VDE (German Electrical Engineers Association), specifically to VDE 0100, VDE 0113, VDE 160.

5. EMC-equitable assembly

According to EMC standards thyristor controllers are regarded as components, which do not fulfil any intended use by themselves. The devices constitute a functional unit of the entire plant. The control electronics of the thyristor controllers are implemented according to valid EMC standards.

The builder of the plant has to supply the plant with appropriate mains chokes and mains filters. These components can also be obtained from us. Thyristor controllers with multicycle control usually do not require any additional mains filter circuit.

It should be noted that the standards of the resource category A are not sufficient in a special industrial sector, for example if sensitive measuring channels are affected. In this case, the user has to apply equipment of class B.

The class A is the usual class of equipments, which is normally intended for the use in the industrial sector. The devices are connected to the industrial network via an assigned transformer. Power controllers of class B are required if they should be used in the area of industry and small-scale industry and if they should be connected to the public low-voltage system.

Use of mains chokes:

On the input side of the thyristor controllers, mains chokes reduce the current-dependent line reactions and effect an improvement of the performance factor. This reduces the current harmonics and improves the mains quality. The use of mains chokes is particularly recommended when connecting thyristor controllers with phase angle control to a grid-feeding point and when other electronic devices are attached to this network.

Use of mains filters:

Radio interference filters and mains filters (combination of radio interference filter and one mains choke) serve for protection against high-frequency disturbances, which are sent out via the power cable or the radiation of the power cable. The high-frequency disturbances should be limited to a mandatory or legal degree. Mains filters should possibly be mounted close to the thyristor controller and moreover it is necessary to ensure that the connecting cable between the thyristor controller and the mains filter is as short as possible.

CAUTION: The mounting surfaces of the thyristor controllers and the radio interference filters have to be free from paint and well conducting in the high-frequency range.

Furthermore, mains filters have leakage currents, which may become significantly larger than the nominal values in case of failure (phase failure, unbalanced load). To avoid dangerous voltages, the mains filters have to be grounded. As the leakage currents are high-frequent disturbances, the grounding measures have to be low-resistance and extensive.

With leakage currents, which exceed the value of 3,5mA, VDE 0160 or EN 60335 specify that either:

- the cross section of the protective conductor has to be $\geq 10\text{mm}^2$,
- the protective conductor has to be monitored on interruption or
- a second protective conductor has to be laid.

Shielding measures:

Shielding measures help to reduce the radiated interference energy. Electrical lines between thyristor controller and load can be laid shielded. Thereby the shield must not replace the PE line. Four-wire cables (three phases + PE), whose shield is double-sided and extensive laid on earth potential (PES), are recommended. The shield must not be applied over the connecting wires. Interruptions of the shielding e.g. in the case of clamps, contactors, mains chokes etc. have to be bridged with low-resistance and appropriate space considerations.

In practice this can be done for example by interrupting the shield close to the assembly and then connecting it extensively with the earth potential (PES, shield clamp). The free cables, which are not shielded, should not be longer than 100mm.

Grounding measures:

Grounding measures are absolutely necessary to fulfil legal provisions. They constitute a prerequisite for an efficient use of further measures such as filters and shielding. All conductive, metallic housing components have to be electroconductive connected with the earth potential. For the EMC-measure, the important factor is not the cable's crosssection, but its surface, since this is where high frequency current flows to earth. Once again, all grounding points have to be led directly, extensively and with low-resistance to the central grounding point (equipotential bonding bar, star-shaped grounding system). The contact points have to be free from paint and corrosion (use galvanized mounting plate and materials).

6. Operation



To begin with, the electrical connections are to be done, according to the accompanying plans: L1, L2, L3 (rotating field right), T1(U), T2(V), T3(W).

The thyristor controller have to be connected to the power supply according to the VDE rules, in a way that they can be disconnected again by appropriate switching means (i.e. master switch, contactor, protective power switch).

Conducting wire installation:

The power supply, the user supply, as well as the control wiring have to be placed in separate ducts or conduits.

To avoid malfunction, it is advisable, to install the electronic signal wiring separated from the power supply and/or from the protective control wiring as well as to twist the feed and return signal lines or use shielded control lines (see also point 5. EMC-equitable assembly).

Fuses:

The mains fuse protection depends on the recommended or employed power-transmission crossection and has to be carried out, according to DIN 57100, part 430/VDE 0100 and part 430/6.81.

The options /ES (electronic switch-off), /IB (electronic current limitation), /IS (symmetric current monitoring) and /IU (low current recognition) provide a malfunction report output with a simultaneous LED display.

The control electronics synchronously turn off the current of the power element.

General information on the PTC-thermistor:

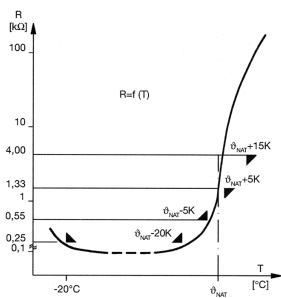

PTC-temperature sensors according to DIN 44081 (triplet design DIN 44082) are used to protect electrical machines against thermal overload. According to the present DIN standard they are arbitrarily exchangeable among themselves. It is a range of types from 60 to 190°C available.

PTC-temperature sensors with different rated shut-off temperatures can also be connected in series. Thereby it is possible to get optimum use out of machine Components and winding parts with different limit temperatures and to protect them cost-effectively.

Technical data PTC

	Single	Triplet	
Tolerance of ϑ_{NAT}	± 5	± 5	K
Reproducibility of ϑ_{NAT}	$\pm 0,5$	$\pm 0,5$	K
Cold resistance R_{25}	≤ 100	≤ 300	Ω
Cold resistance at a cold-conductor temperature of $\vartheta_{NAT} -5K$	≤ 550	≤ 1650	Ω
Cold resistance at a cold-conductor temperature of $\vartheta_{NAT} +5K$	≥ 1330	≥ 3990	Ω
Cold resistance at a cold-conductor temperature of $\vartheta_{NAT} +15K$	≥ 4	≥ 12	k Ω
Thermal response time t_a	≤ 5	≤ 5	s

7. Technical features of the control and monitoring panel

The control and monitoring unit includes various control and safety functions. This panel will be internally supplied through the mains voltage. On the control and monitoring panel is the exchangeable function board (100 x 75 mm) mounted, which defines the control mode of the device.

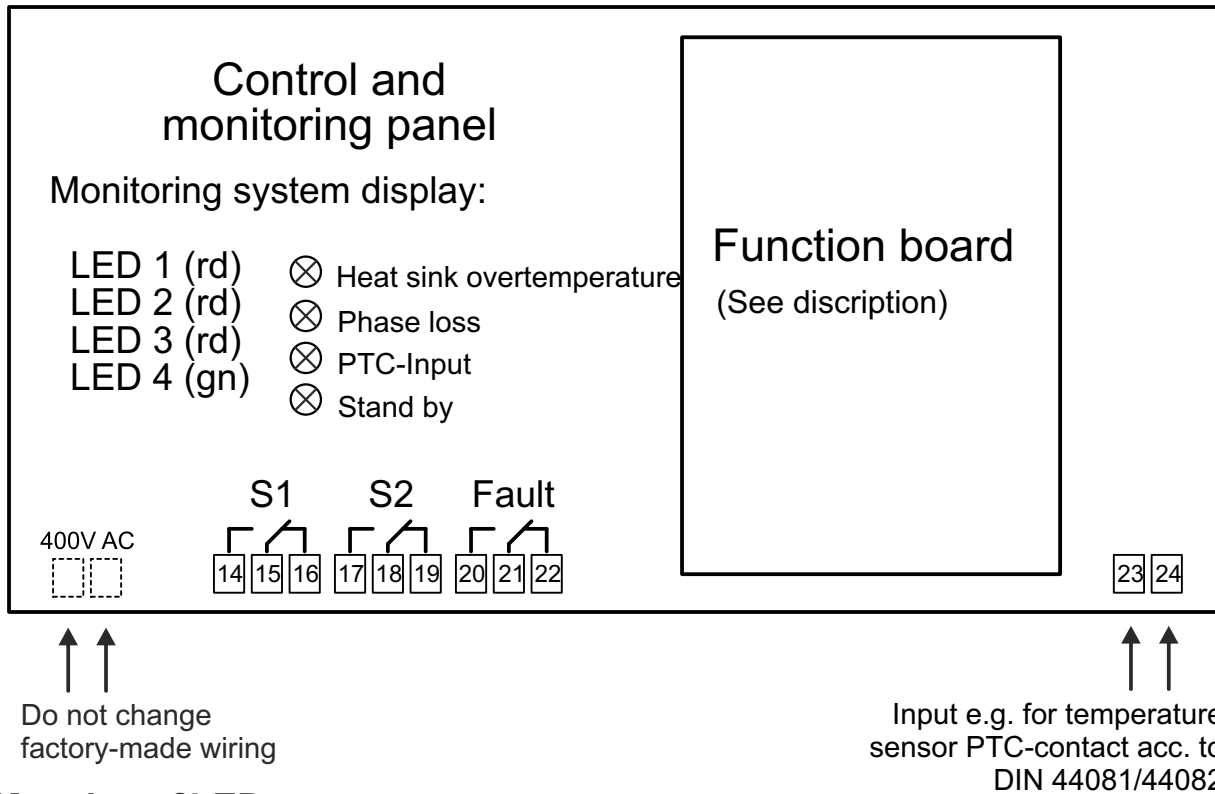

7.1 Meaning of LEDs

LEDs on the control and monitoring panel

LED 1 (rd)	Meaning: Over temperature of heat sink or power unit Reason: Overload, to high current, to high switching frequency, to high ambient temperature, The threshold value of turning off is at 85° C.
LED 2 (rd)	Meaning: Phase failure Reason: One or more phases are not connected with the mains connections L1, L2, L3 (Check the contacts!)
LED 3 (rd)	Meaning: Over temperature of the PTC-sensor or clamps 23-24 are opened Reason: PTC has released or missing bridge on clamps 23-24
LED 4 (gn)	Meaning: Mains voltage connected (device in operation)

If there is none of the explained malfunctions, all red LEDs have to go out by activating the device (e.g. by connecting the contacts 1 - 2 / reset procedure).

LEDs on the function board

LED "SE"	Activation
LED "S1"	Switch function S1 activated (simultaneous activation of relais contacts S1 and LED S1), load voltage > 0%
LED "S2"	Switch function S2 activated (simultaneous activation of relais contacts S1 and LED S2), load voltage = 100 %

7.2 Meaning of the clamp connections

Clamp connections on the function panel:

These connections can be found on the function module and obey the following numbering scheme.

Activation:	
1, 2	activated: closed standby: open
3, 4	nominal control signal 0...10V, 0...20mA or 4...20mA

Special functions:	
5, 6	disable the power unit: open (The red LED lights if clamps 5 - 6 are opened)
5, 6	in operation: closed
7	reference voltage 10V DC (voltage supply for potentiometer control)

Clamps on the control and monitoring print:

400VAC	The devices are powered internal by the mains voltage. Optional can devices with different mains voltage be supplied with an external auxiliary voltage.
14, 15, 16	switching output S1, load voltage > 0% on clamps T1, T2, T3 Contact positions see time diagram
17, 18, 19	switching output S2, load voltage = 100% on clamps T1, T2, T3 Contact positions see time diagram
20, 21, 22	malfunction report output switch terminal Contact positions: <ul style="list-style-type: none"> • without auxiliary voltage in normal operation: 21 - 22 closed • with auxiliary voltage in normal operation: 21 - 22 closed • without auxiliary voltage at the fault: 21 - 22 closed • with auxiliary voltage at the fault: 21 - 20 closed
23, 24	auxiliary input, i.e. for PTC-sensor according to DIN 44081 or other applications <ul style="list-style-type: none"> • 23 - 24 open = error (disable the power unit) • 23 - 24 closed = operation

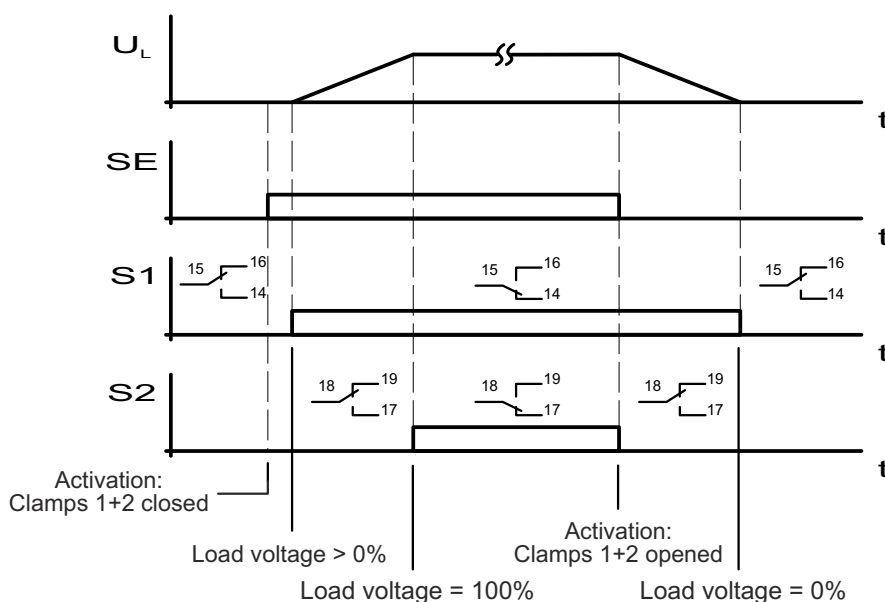

The switch positions show the clamp contacts from 14 to 19 at the control panel.

8. Control and monitoring print

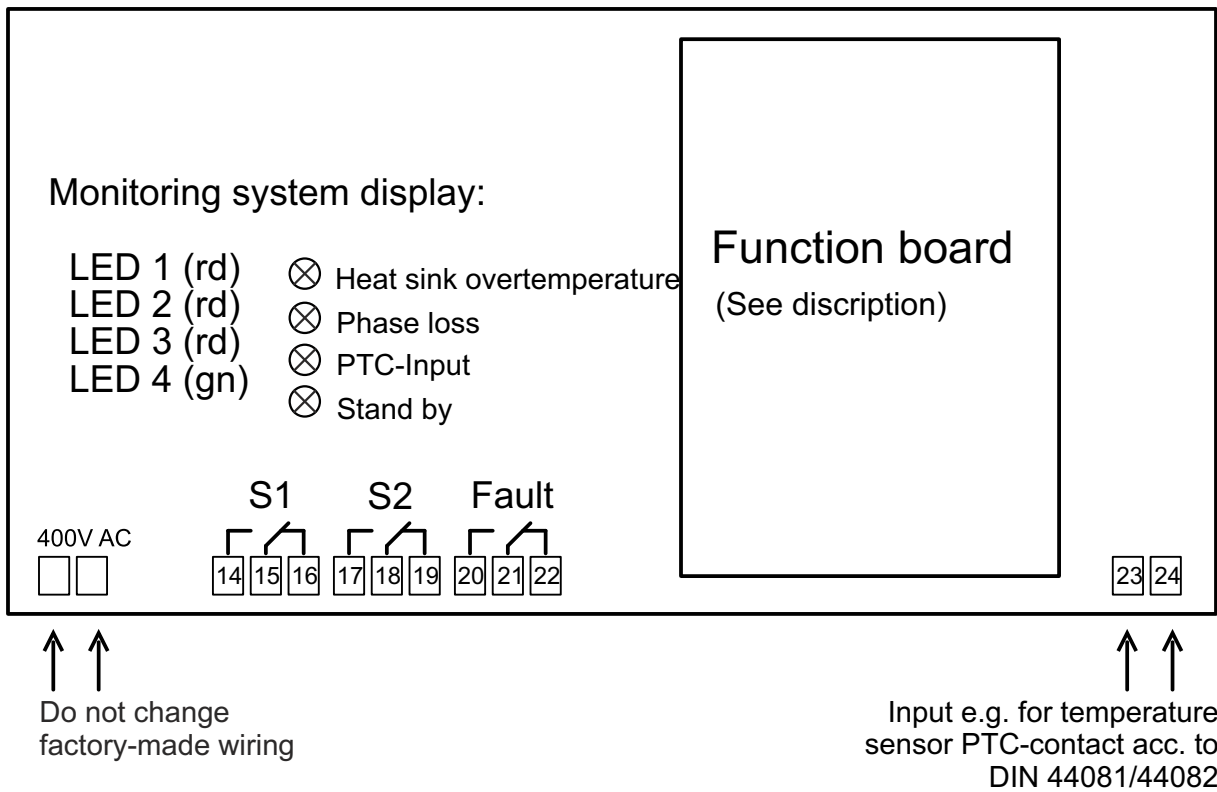

Explanation of the LED indicators

LED 1	Over temperature of heat sink or power unit (switch-off threshold is about 85°C)
LED 2	phase failure, undervoltage
LED 3	Over temperature of the PTC-sensor or clamps 23-24 are opened
If there is one of the explained errors, it will be saved and the error indication will be activated. (clamps 20-21-22)	
LED 4	ready for use, mains voltage is applied

Auxiliary contacts S1 and S2

User-defined alternating contacts (5A/230V), activated by the following switching position:

U_L	output voltage of the thyristor controller at T1, T2, T3
S1	Load voltage > 0%
S2	Load voltage = 100%

Contacts 20, 21, 22 Malfunction

Switching output Error indication

Contacts:

- without mains voltage by normal operation: 21 - 22 closed
- with mains voltage by normal operation: 21 - 22 closed
- without mains voltage by fault signal: 21 - 22 closed
- with mains voltage by normal operation: 21 - 20 closed

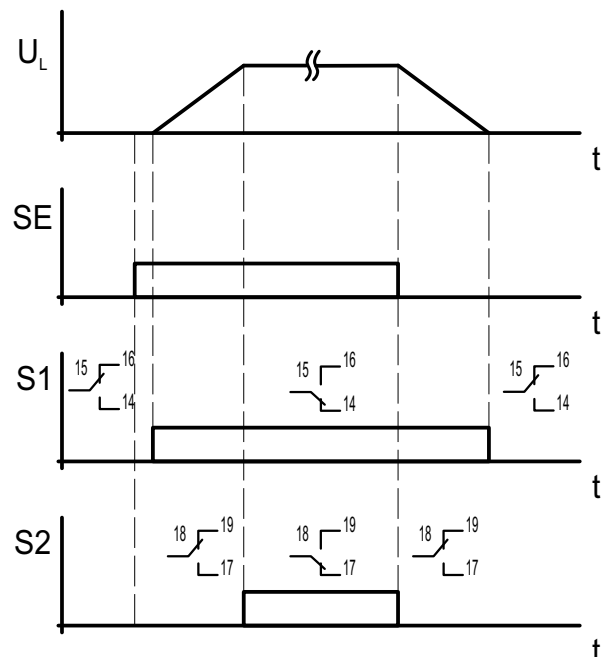

9. Control unit

9.1 Function board

Controlling of thyristor controllers by analogous signals

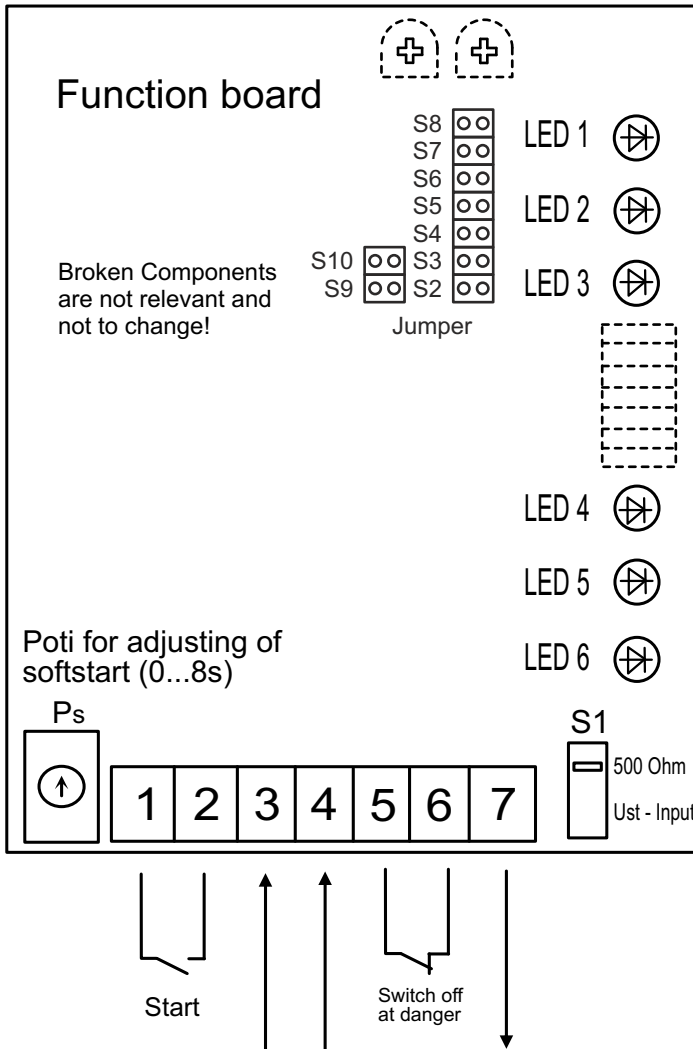

Meaning of LEDs:







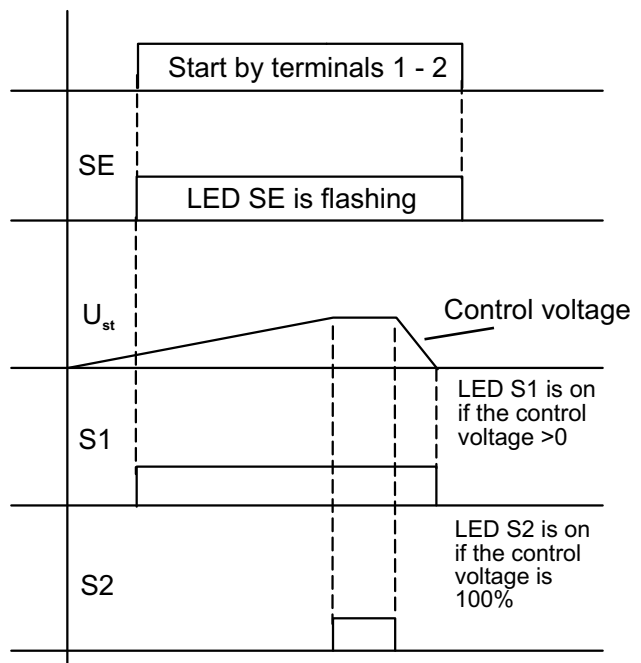
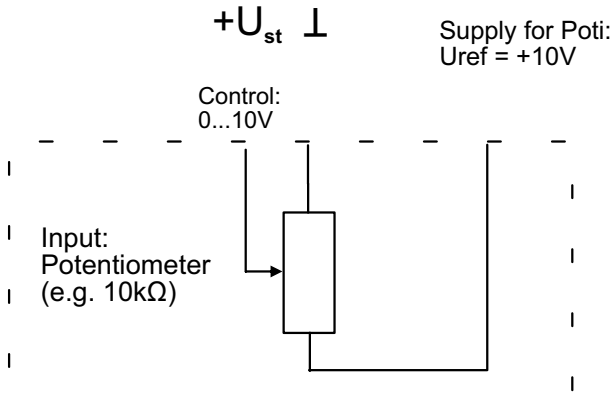















































- LED 1:**
The light intensity of the display is dependent on the height of the control (no meaning for devices with multicycle control);
- LED 2:**
Flashes, when multicycle control is active, is dependent of the control 1Hz (no meaning for devices with phase control);
- LED 3:**
An open contact 5/6 the LED 3 lights up. Likewise, this LED shows faults on the control panel;
- LED 4:**
Input: SE (LED 4)
Lights up Activation;
- LED 5:**
Output: S1 (LED 5)
Lights up, when control signal >0;
- LED 6:**
Output: S2 (LED 6)
Lights up, when 100% output voltage is reached;

Switch S1 (500 Ohm):

- Current control (e.g.: for 0...20mA);
- Voltage control $R_i > 50k$ (e.g.: for 0...10V);



9.2 Settings for the varios controls

	Phase angle control	Mutlicycle control
Control: 0...10V	Switch S1: OFF	Switch S1: OFF
	Jumper S2 closed 	Jumper S2 open 
	Jumper S3 open 	Jumper S3 open 
	Jumper S4 closed 	Jumper S4 closed 
	Jumper S5 closed 	Jumper S5 open 
	Jumper S6 open 	Jumper S6 open 
	Jumper S7 open 	Jumper S7 closed 
	Jumper S8 closed 	Jumper S8 open 
	Jumper S9 open 	Jumper S9 open 
	Jumper S10 offen 	Jumper S10 open 
Control: 0...20mA	Switch S1: ON	Switch S1: ON
	Jumper S2 closed 	Jumper S2 open 
	Jumper S3 open 	Jumper S3 open 
	Jumper S4 closed 	Jumper S4 closed 
	Jumper S5 closed 	Jumper S5 open 
	Jumper S6 open 	Jumper S6 open 
	Jumper S7 open 	Jumper S7 closed 
	Jumper S8 closed 	Jumper S8 open 
	Jumper S9 open 	Jumper S9 open 
	Jumper S10 open 	Jumper S10 open 
Control: 4...20mA	Switch S1: ON	Switch S1: ON
	Jumper S2 closed 	Jumper S2 open 
	Jumper S3 closed 	Jumper S3 closed 
	Jumper S4 open 	Jumper S4 open 
	Jumper S5 closed 	Jumper S5 open 
	Jumper S6 open 	Jumper S6 open 
	Jumper S7 open 	Jumper S7 closed 
	Jumper S8 closed 	Jumper S8 open 
	Jumper S9 open 	Jumper S9 open 
	Jumper S10 open 	Jumper S10 open 

10. Basic circuit

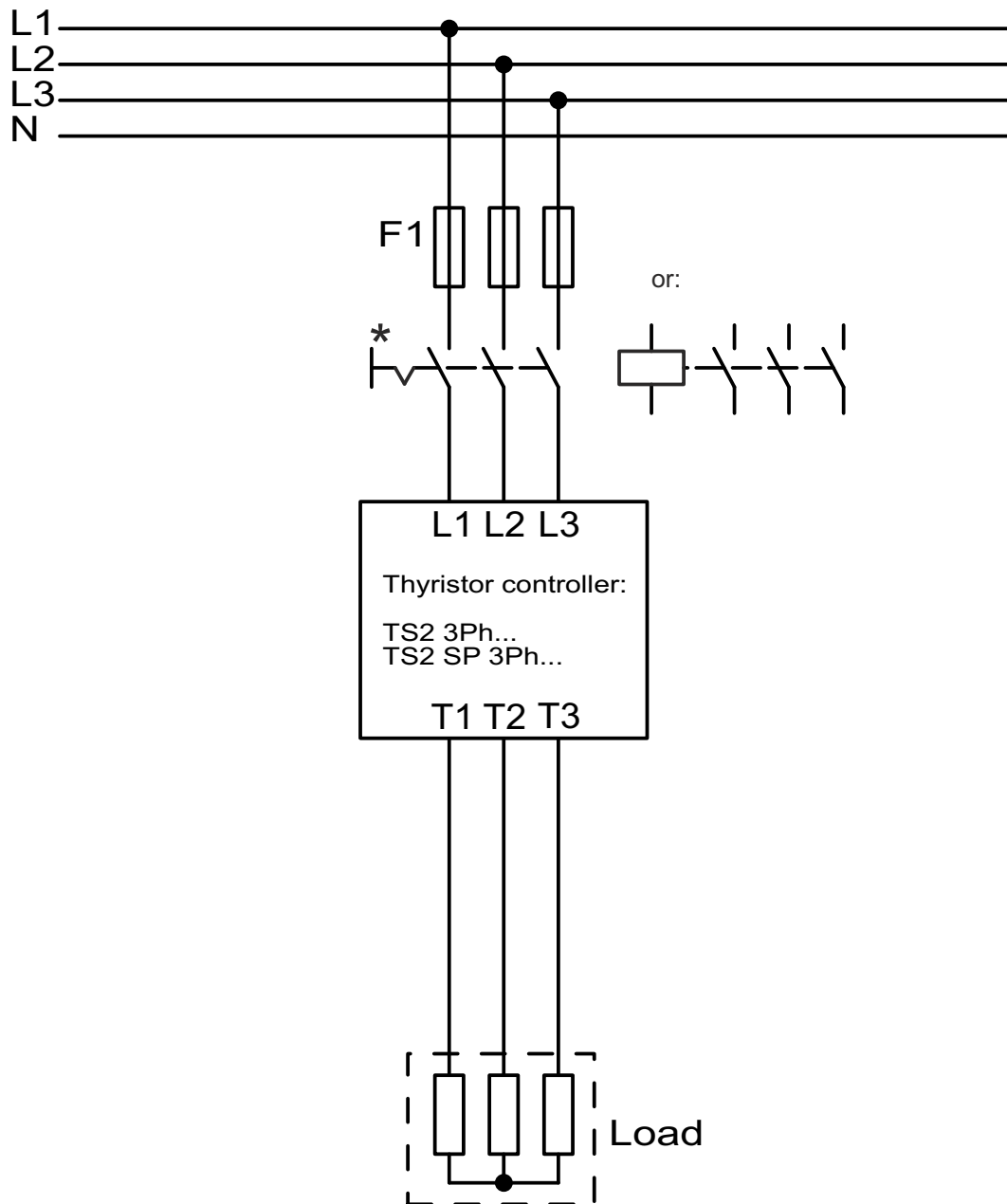

Follow the clockwise phase shift!

* For disconnection plug connectors, fuses, circuit-breakers, load-breakers, residual current devices (RCDs), etc. can be used.

11. Survey of the individual types

Type*	max. load current	rec. semi-conductor fuses	Mains fuse	rec. cross-section	max. power**	Power loss at nominal rating	Weight	Frame size	Dimensions WxHxD
	[A]	[A]	[A]	[mm ²]	[kW]	[W]	[kg]		[mm]
TS2 3Ph 05	5	10	16	1,5	3	13	1,3	A	200x140x115
TS2 3Ph 08	8	15	16	1,5	5	22	1,3	A	200x140x115
TS2 3Ph 15	15	25	25	2,5	10	40	1,9	B	260x205x170
TS2 3Ph 25	25	30	25	4,0	16	67	1,9	B	260x205x170
TS2 3Ph 35	35	40	35	6,0	23	94	2,3	B	260x205x170
TS2 3Ph 50	50	60	50	10	33	135	2,3	B	260x205x170
TS2 3Ph 60	60	80	80	16	41	162	2,4	B	260x205x170
TS2 3Ph 75	75	80	80	16	50	202	7,0	C	360x252x200
TS2 3Ph 90	90	100	100	25	60	243	7,5	C	360x252x200
TS2 3Ph 120	120	130	125	35	78	324	9,5	C	360x252x200
TS2 3Ph 160	160	200	160	50	100	432	10,5	C	360x252x200
TS2 3Ph 220	220	300	250	70	145	594	15,0	D	360x445x210
TS2 3Ph 280	280	400	315	95	193	756	15,0	D	415x525x210
TS2 3Ph 350	350	450	355	120	240	945	18,0	D	415x525x210
TS2 3Ph 420	420	600	400	150	290	1134	22,0	D	415x525x210
TS2 3Ph 560	560	750	630	240	380	1512	28,0	E	600x540x346
TS2 3Ph 720	720	900	800	300	490	1944	30,0	E	600x540x346
TS2 3Ph 1000	1000	1200	1000	500	690	2700	32,0	E	600x540x346
TS2 3Ph 1250	1250	1800	1250	630	860	3375	79,0	F	850x750x470
TS2 3Ph 1600	1600	2000	1600	2x400	1100	4320	82,0	F	850x750x470
TS2 3Ph 1850	1850	2500	2000	2x500	1300	4710	90,0	F	850x750x470
TS2 3Ph 2100	2100	2500	2000	2x500	1450	5010	90,0	F	850x750x470
TS2 3Ph 2500	2500	2800	2500	2x630	1730	5790	93,0	F	850x750x470

Errors and technical modifications excepted (Date: 2018/03)

Recommendations of the cross sections according to VDE 0298-4 (August 2003), table 4, laying system E and F

* The given details also apply to the version with multicycle control ESGT-3Ph/SP...

** The given values for the max. power applies to operation at 3x 400V. The circuit can be in star connection or delta connection. To take account of this, the resistance values of the load. (Example: Power resistors for 230V AC can't be connected in delta connection)

The given values refer to the operation voltage of 3x400V AC.

The values given for overload refer to a surrounding temperature exceed of max. 55°C and an installation altitude of 1000m. (VDE 0298 part 4, August 2003).

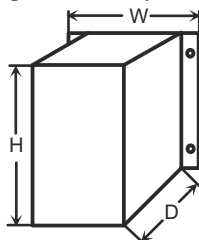

12. Technical data

Mains voltage	400V AC, 50-60Hz (optional: further mains voltages available)
Auxiliary voltage	generation intern
Max. load current	see table on page 15 (5...2500A)
Mains frequency	48Hz...62Hz
Phase sequence	self synchronizing
Types of the load	ohmic and inductive load
Kind of protection	IP 23
Protection class	E according to DIN 40040
Built in device	VDE 0160 5.5.1.3 / DIN EN 50178
Installation	vertical, electrical connections downside
Indication of operation state	LEDs (SE, S1, S2)
Ambient temperature	0...+55°C
Current limiting (optional)	5...100% of the I_n
Error indication	phase failure, undervoltage, over temperature, PTC-input
CE-regulations	EMC Directive 2014/30/EU LVD 2014/35/EU
Control signals (standard)	<ul style="list-style-type: none"> • 0...10V DC • 0...20mA DC • 4...20mA DC • potentiometer input (5kΩ...25kΩ): 0...10V DC
optional	<ul style="list-style-type: none"> <li style="width: 50%;">• 0...5V DC <li style="width: 50%;">• 10...0V DC (invers) <li style="width: 50%;">• 0...10mA DC <li style="width: 50%;">• 20...4mA (invers) <li style="width: 50%;">• 0...5mA DC <li style="width: 50%;">• 20...0mA (invers)

14. Frame sizes

Frame size: A

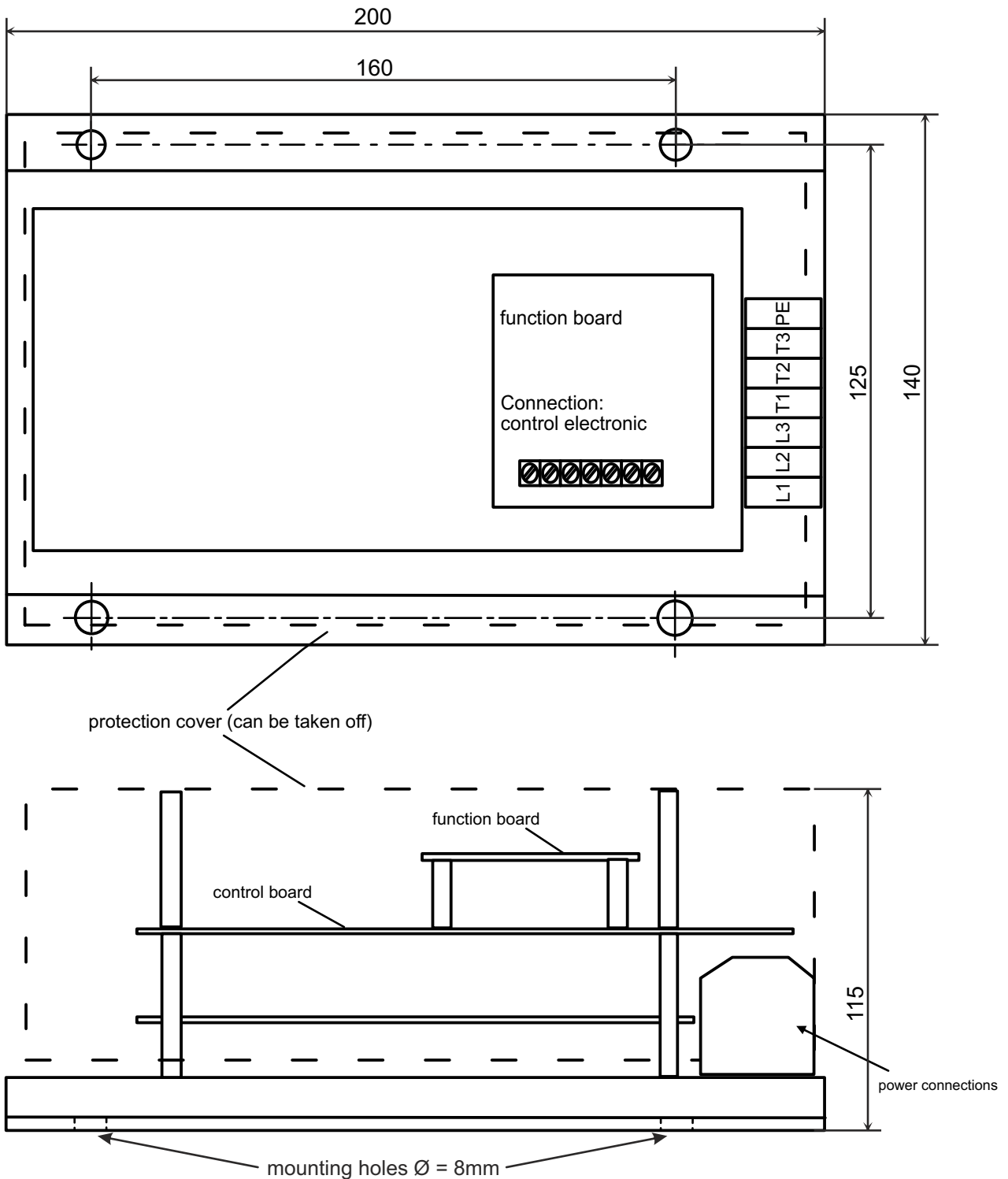

Power connections (L1...T3): according to version
(TS2 3Ph 05, 08, frame size A)

Frame size: B

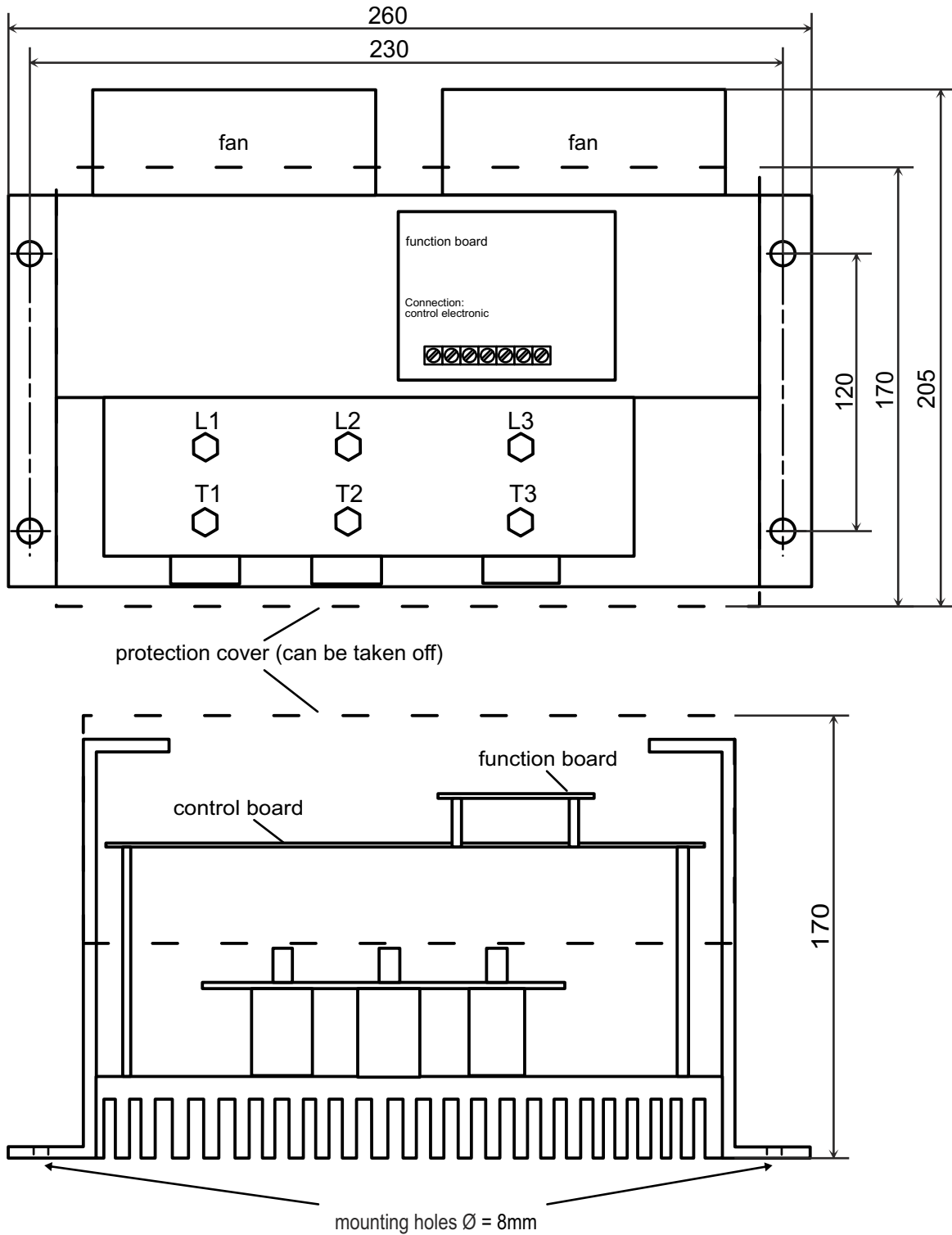

Power connections (L1...T3): 1,5 to 6mm²
 (TS2 3Ph 15, 25, 35, 50, 60, frame size B)

Frame size: C

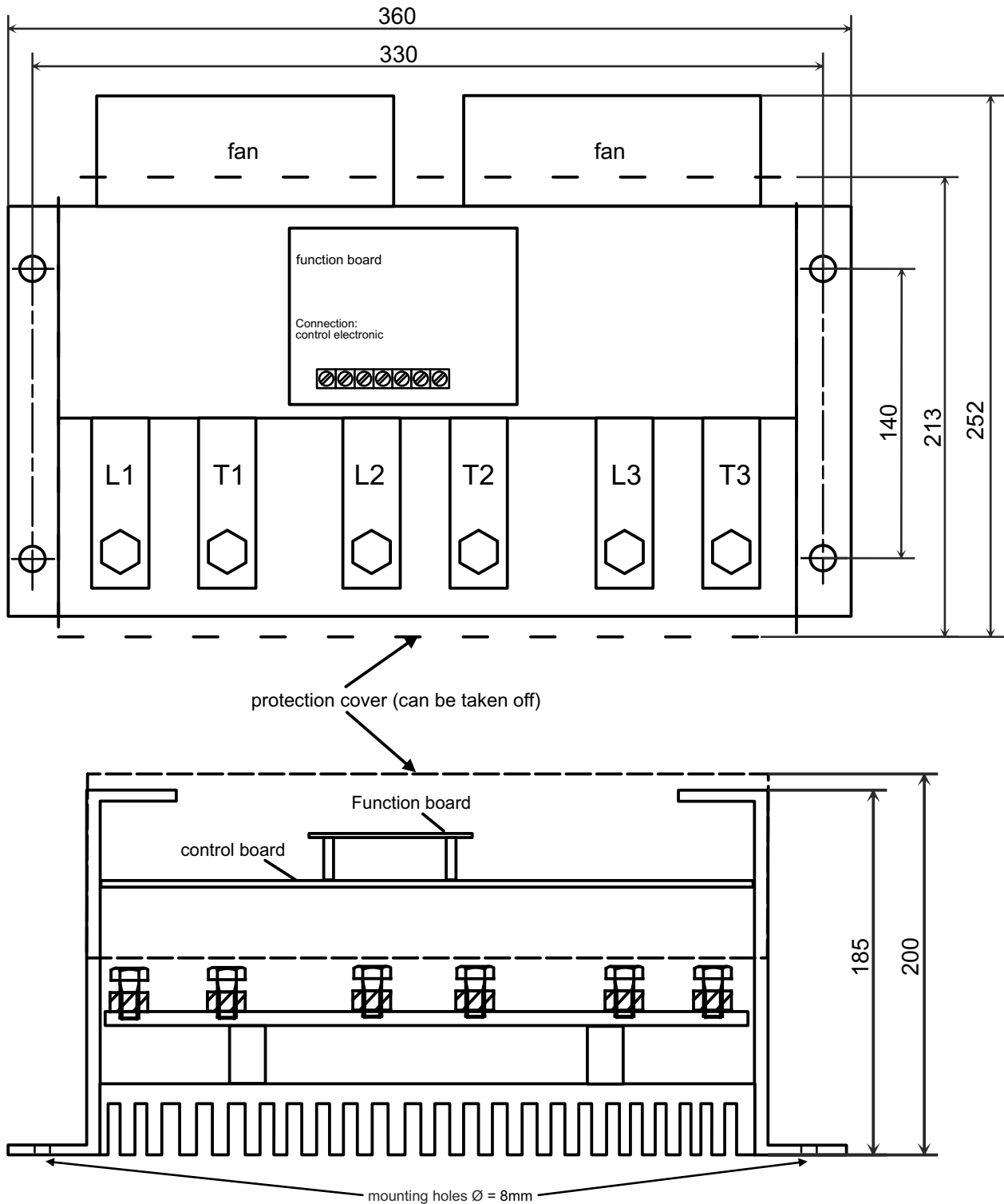

Power connections (L1...T3): M8
(TS2 3Ph 75, 90, 120, 160, frame size C)

Frame size: D

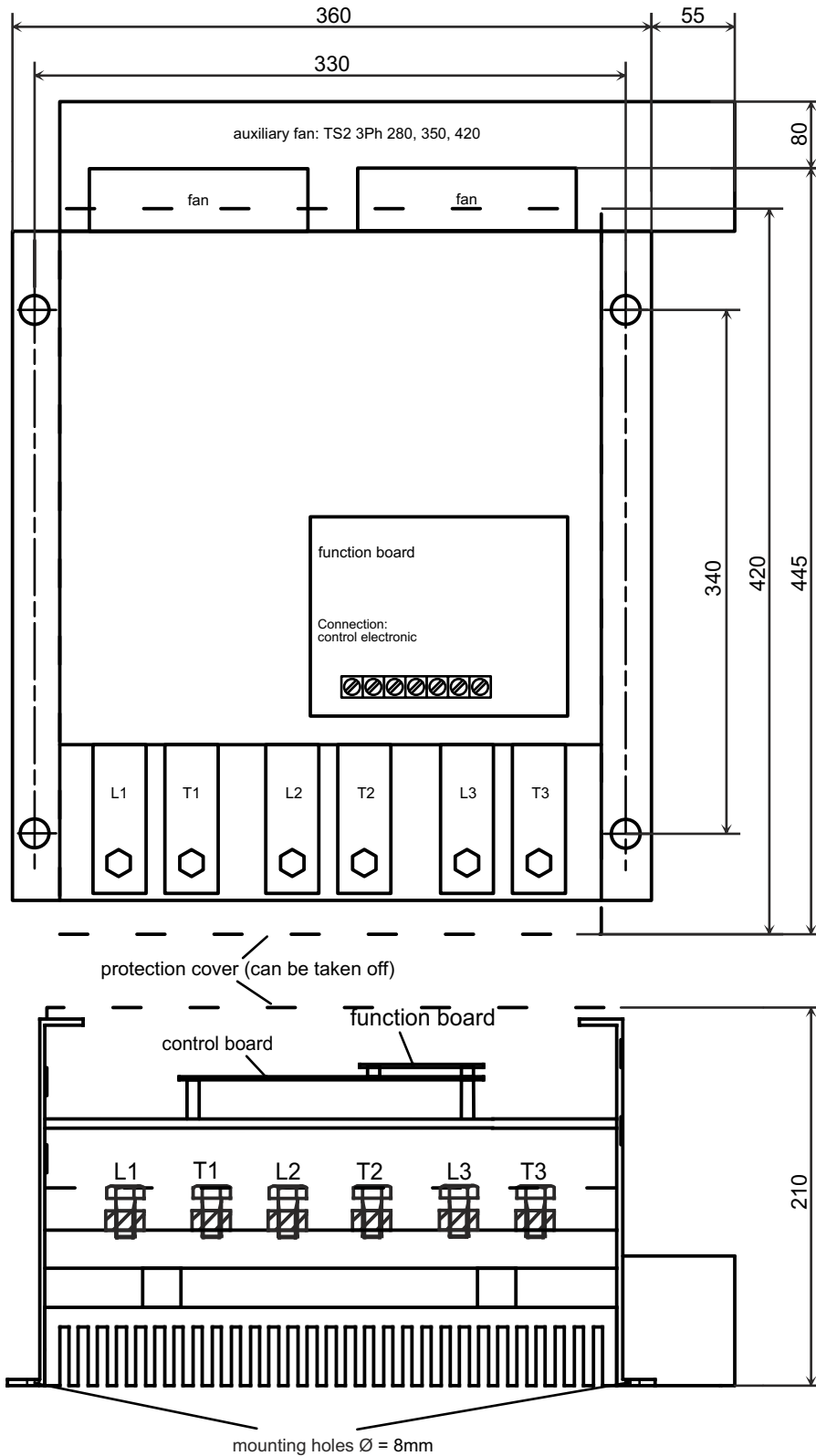

Power connections (L1...T3): M8
(TS2 3Ph 220, 280, 350, 420, frame size D)

Due to ongoing technical development and modifications we reserve the right to deliver products which might be slightly different from those described above.

Frame size: E

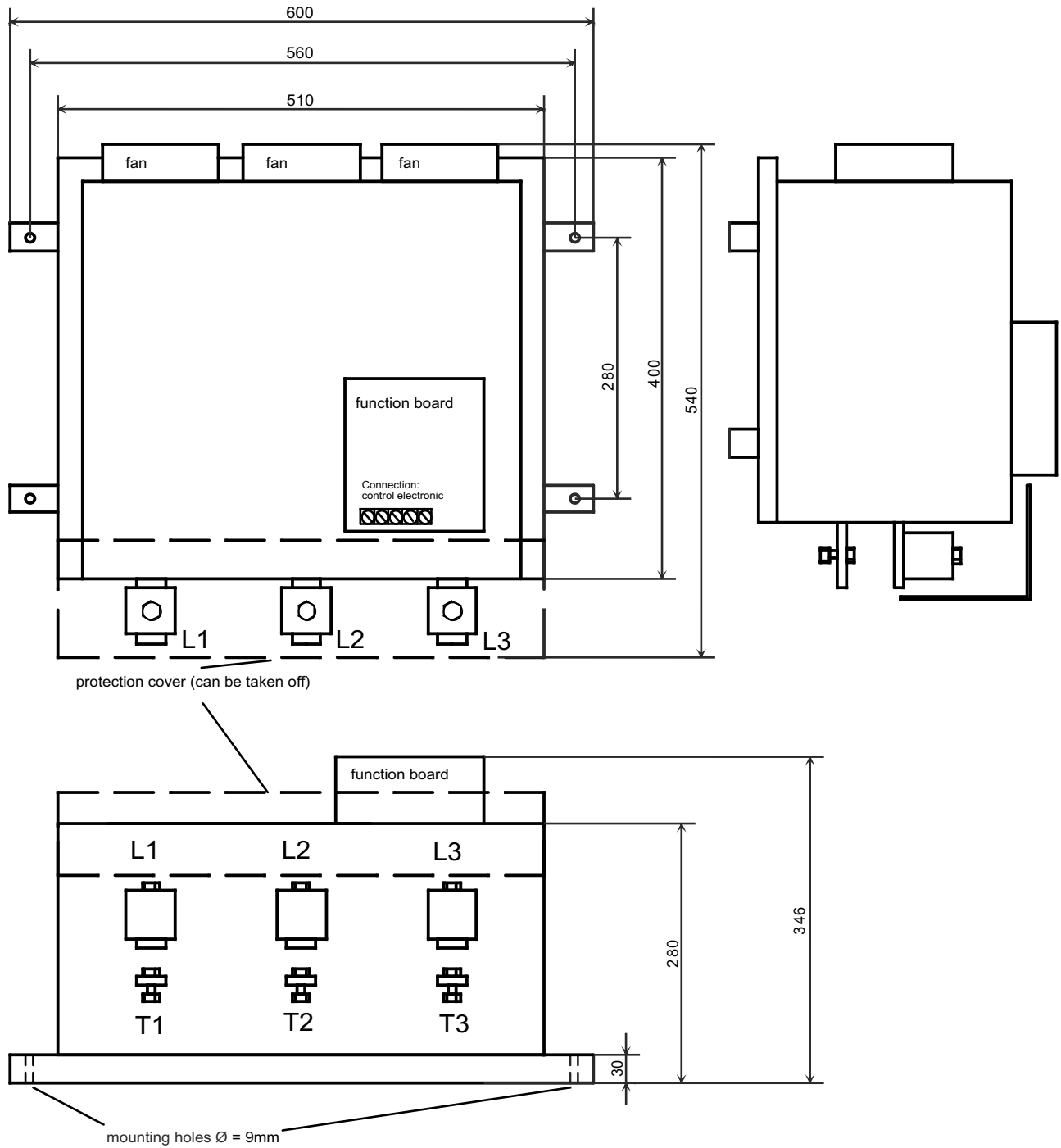

Power connections (L1...T3): M10 / M8
(TS2 3Ph 560, 720, 1000, frame size E)

Frame size: F

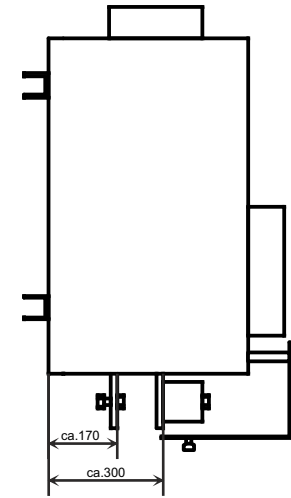
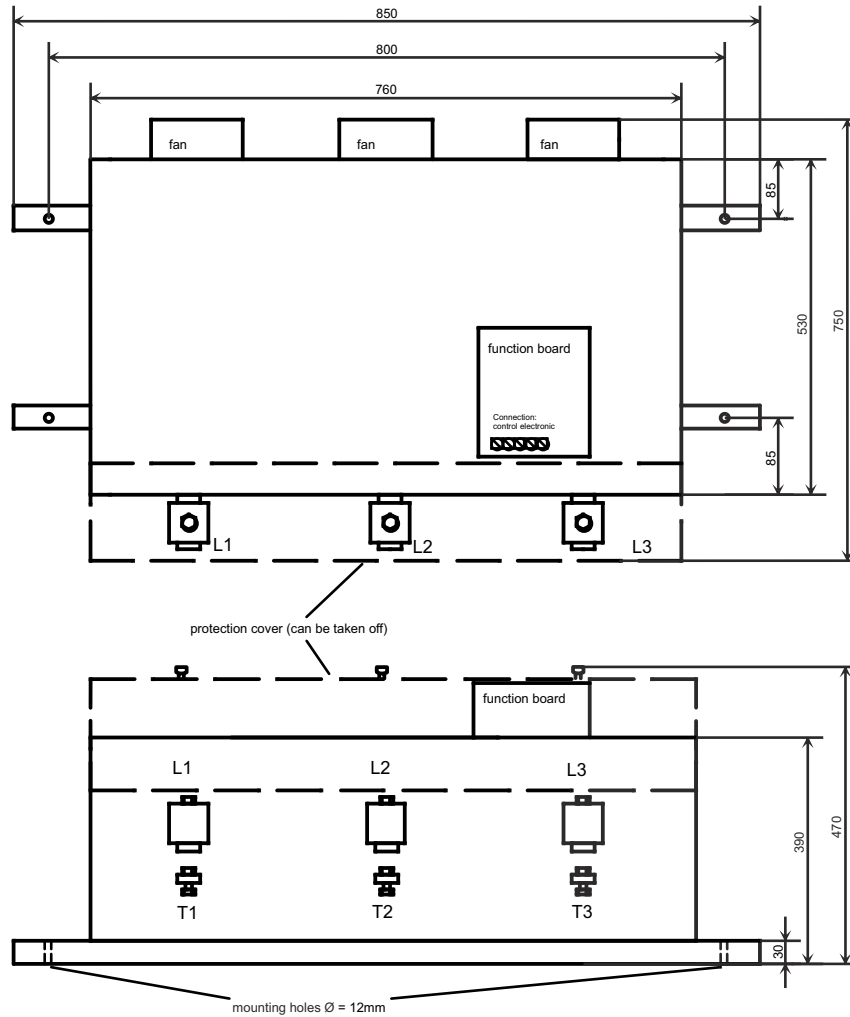

Power connections (L1...T3): M12
(TS2 3Ph 1250, 1600, 1850, 2100, 2500, frame size F)

Due to ongoing technical development and modifications we reserve the right to deliver products which might be slightly different from those described above.